

**HANDHELD  
DIGITAL MULTIMETER**

**OPERATOR'S  
INSTRUCTION MANUAL**

## Table of Contents

<i>TITLE</i>	<i>PAGE</i>
<b>1. GENERAL INSTRUCTIONS</b>	<b>1</b>
1.1 Precaution safety measures	1
1.1.1 Preliminary	1
1.1.2 During use	2
1.1.3 Symbols	4
1.1.4 Instructions	5
1.2 Protection mechanisms	6
<b>2. DESCRIPTION</b>	<b>6</b>
2.1 Instrument Familiarization	6
2.2 LCD Display	7
2.3 Key pad	8
2.4 Terminals	9
2.5 Accessories	9
<b>3. FUNCTION DESCRIPTION</b>	<b>10</b>
3.1 General Functions	10
3.1.1 DATA HOLD mode	10
3.1.2 Battery saver	10
3.2 Measurement Functions	10
3.2.1 AC and DC Voltage measurement	10
3.2.2 Resistance measurement	11
3.2.3 Diode Test	12
3.2.4 Continuity Check	13

I

## Table of Contents

<i>TITLE</i>	<i>PAGE</i>
3.2.5 Capacitance measurement	14
<b>3.2.6 Transistor measurement</b>	<b>15</b>
3.2.7 Current measurement	15
<b>4. TECHNICAL SPECIFICATIONS</b>	<b>17</b>
4.1 General specifications..	17
4.2 Measurement specifications	18
4.2.1 DC Voltage	18
4.2.2 AC Voltage	18
4.2.3 Resistance	19
4.2.4 Diode Test	19
4.2.5 Continuity Check	19
<b>4.2.6 Transistor</b>	<b>19</b>
4.2.7 Capacitance	20
4.2.8 DC Current	20
4.2.9 AC Current	20
<b>5. MAINTENANCE</b>	<b>21</b>
5.1 General maintenance	21
5.2 Battery replacement	21

II

## 1. GENERAL INSTRUCTIONS

This instrument complies with IEC 1010-1 (61010-1@IEC: 2001), CAT. II 1000V and CAT. III 600V overvoltage standards. See Specifications.

To get the best service from this instrument, read carefully this user's manual and respect the detailed safety precautions.

International symbols used on the Meter and in this manual are explained in chapter 1.1.3

### 1.1 Precautions safety measures

#### 1.1.1 Preliminary

\* Measurement category III is for measurements performed in the building installation.

NOTE: Examples are measurements on distribution boards, circuit-breakers, wiring, including cables, bus-bars, junction boxes, switches, socket-outlets in the fixed installation, and equipment for industrial use and some other equipment, for example, stationary motors with permanent connection to the fixed installation.

\* Measurement category II is for measurements performed on circuits directly connected to the low voltage installation.

NOTE: Examples are measurements on household appliances, portable tools and similar equipment.

\* Measurement category I is for measurements performed on circuits not directly connected to MAINS.

NOTE: Examples are measurements on circuits not derived from MAINS, and specially protected (internal) MAINS derived circuits. In the latter case, transient stresses

are variable; for that reason, requires that the transient withstand capability of the equipment is made known to the user.

- \* When using this Multimeter, the user must observe all normal safety rules concerning:
  - protection against the dangers of electric current.
  - protection of the Multimeter against misuse.
- \* For your own safety, only use the test probes supplied with the instrument. Before use, check that they are in good condition.

#### 1.1.2 During use







- \* If the meter is used near noise generating equipment, be aware that display may become unstable or indicate large errors.
- \* Do not use the meter or test leads if they look damaged.
- \* Use the meter only as specified in this manual; otherwise, the protection provided by the meter may be impaired.
- \* Use extreme caution when working around bare conductors or bus bars.
- \* Do not operate the meter around explosive gas, vapor, or dust.
- \* Verify a Meter's operation by measuring a known voltage. Do not use the Meter if it operates abnormally. Protection may be impaired. When in doubt, have the Meter serviced.
- \* Uses the proper terminals, function, and range for your measurements.
- \* When the range of the value to be measured is unknown, check that the range initially set on the multimeter is the highest possible or, wherever possible, choose the autoranging mode.

- \* To avoid damages to the instrument, do not exceed the maximum limits of the input values shown in the technical specification tables.
- \* When the multimeter is linked to measurement circuits, do not touch unused terminals.
- \* Caution when working with voltages above 60Vdc or 30Vac rms. Such voltages pose a shock hazard.
- \* When using the probes, keep your fingers behind the finger guards.
- \* When making connections, connect the common test lead before connecting the live test lead; when disconnecting, disconnect the live test lead before disconnecting the common test lead.
- \* Before changing functions, disconnect the test leads from the circuit under test.
- \* For all dc functions, including manual or auto-ranging, to avoid the risk of shock due to possible improper reading, verify the presence of any ac voltages by first using the ac function. Then select a dc voltage range equal to or greater than the ac range.
- \* Disconnect circuits power and discharge all high-voltage capacitors before testing resistance, continuity, diodes, or capacitance.
- \* Never perform resistance or continuity measurements on live circuits.
- \* Before measuring current, check the meter's fuse and turn off power to the circuit before connecting the meter to the circuit.

- \* In TV repair work, or when carrying out measurements on power switching circuits, remember that high amplitude voltage pulses at the test points can damage the multimeter. Use of a TV filter will attenuate any such pulses.
- \* Use the 9V NEDA battery, properly installed in the Meter's battery case, to power the Meter.
- \* Replace the battery as soon as the battery indicator (  ) appears. With a low battery, the Meter might produce false readings that can lead to electric shock and personal injury.
- \* Do not measure voltages above 600V in Category III, or 1000V in Category II installations.
- \* Do not operate the Meter with the case (or part of the case) removed.

### 1.1.3 Symbols:

Symbols used in this manual and on the instrument:

- |   |  |
|---|--|
|    | <b>Caution:</b> refer to the instruction manual. Incorrect use may result in damage to the device or its components. |
|    | AC (Alternating Current)   |
|  | DC (Direct Current)  |
|  | Earth ground   |
|  | Double insulated   |
|  | Fuse   |
|  | Conforms to European Union directives  |

### 1.1.4 Instructions

- \* Remove test leads from the Meter before opening the Meter case or battery cover.
- \* When servicing the Meter, use only specified replacement parts.
- \* Before opening up the instrument, always disconnect from all sources of electric current and make sure you are not charged with static electricity, which may destroy internal components.
- \* Any adjustment, maintenance or repair work carried out on the meter while it is live should be carried out only by appropriately qualified personnel, after having taken into account the instructions in this present manual.
- \* A "qualified person" is someone who is familiar with the installation, construction and operation of the equipment and the hazards involved. He is trained and authorized to energize and de-energize circuits and equipment in accordance with established practices.
- \* When the instrument is opened up, remember that some internal capacitors can retain a dangerous potential even after the instrument is switched off.
- \* If any faults or abnormalities are observed, take the instrument out of service and ensure that it cannot be used until it has been checked out.
- \* If the meter is not going to be used for a long time, take out the battery and do not store the meter in high temperature or high humidity environment.

### 1.2 Protection mechanisms

- \* Fused by the resettable fuse (F200mA/250V) during capacitance, mA and hFE measurements.
- \* A PTC resistor protects against permanent overvoltages of up to 380V during resistance, continuity and diode test measurements.

## 2. DESCRIPTION

### 2.1 Instrument Familiarization

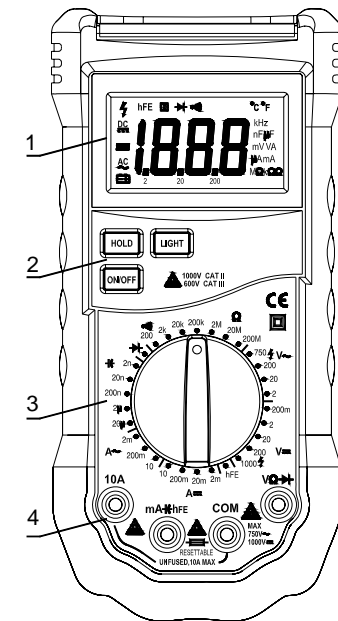

1. LCD display 2. Keypad 3. Rotary switch 4. Terminals

## 2.2 LCD Display

See Table 1 indicated for information about the LCD display.

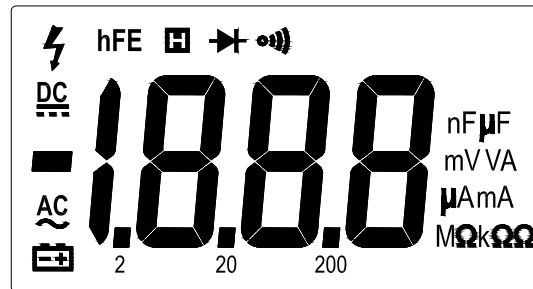

Figure 1. Display  
Table 1. Display Symbols

Symbol	Meaning
	The battery is low. <b>Warning:</b> To avoid false readings, which could lead to possible electric shock or personal injury, replace the battery as soon as the battery indicator appears.
	Indicates negative readings.
	Indicator for ac voltage or current. AC voltage and current are displayed as the average of the absolute value of the input, calibrated to indicate the equivalent rms value of a sine wave.
	Indicator for dc voltage or current.
	The Meter is in the Diode Test mode

Table 1. Display Symbols (continued)

	The Meter is in the Continuity Check mode.
	The Meter is in the Data Hold mode
V, mV	V: Volts. The unit of voltage. mV: Millivolt. $1 \times 10^{-3}$ or 0.001 volts.
A, mA, $\mu$ A	A: Amperes (amps). The unit of current. mA: Milliamp. $1 \times 10^{-3}$ or 0.001 amperes. $\mu$ A: Microamp. $1 \times 10^{-6}$ or 0.000001 amperes
$\Omega$ , k $\Omega$ , M $\Omega$	$\Omega$ : Ohm. The unit of resistance. k $\Omega$ : Kiloohm. $1 \times 10^3$ or 1000 ohms. M $\Omega$ : Megohm. $1 \times 10^6$ or 1,000,000 ohms.
$\mu$ F, nF	F: Farad. The unit of capacitance. $\mu$ F: Microfarad. $1 \times 10^{-6}$ or 0.000001 farads. nF: Nanofarad. $1 \times 10^{-9}$ or 0.000000001 farads.

## 2.3 Keypad

See Table 2 indicated for information about the keypad operations.

Table 2. Keypad

Key	Function	Operation performed
ON/OFF	Any switch position	turn the meter on or off
HOLD	Any switch position	Press <b>HOLD</b> to enter and exit the Data Hold mode.
LIGHT	Any switch position	Press <b>LIGHT</b> to turn the backlight on. After about 5 seconds, the backlight is auto-off.

## 2.4 Terminals

See Table 4 indicated for information about the terminals.

**Table 4. Terminals**

Terminal	Description
<b>COM</b>	Return terminal for all measurements. (Receiving the black test lead or the "com" plug of the special multi-function socket)
<b>→VΩ</b>	Input for voltage, resistance, diode and continuity measurements. (Receiving the red test lead)
<b>mA hFE</b>	Input for capacitance, hFE and 0.001mA to 200mA current measurements. (Receiving the red test lead or the "+" plug of the special multi-function socket)
<b>10A</b>	Input for 200mA to 10A current measurements. (Receiving the red test lead)

## 2.5 Accessories

Delivered with the multimeter:

- User's manual One piece
- Test leads One piece
- Carry case One piece
- Special Multi-function socket One piece